

The TL431 integrated circuits are three-terminal programmable shunt regulator diodes. These monolithic IC voltage references operate as a low temperature coefficient zener which is programmable from Vref to 36 volts with two external resistors. These devices exhibit a wide operating current range of 1.0 to 100mA with a typical dynamic impedance of 0.22 Ω . The characteristics of these references make them

excellent replacements for zener diodes in many applications such as digital voltmeters, power supplies, and op amp circuitry. The 2.5 volt reference makes it convenient to obtain a stable reference from 5.0 volt logic supplies, and since the TL431 operates as a shunt regulator, it can be used as either a positive or negative voltage reference.

FEATURES

- Programmable Output Voltage to 36 Volts
- Low Dynamic Output Impedance, 0.22 Ω Typical
- Sink Current Capability of 1.0 to 100 mA
- Equivalent Full-Range Temperature Coefficient of 50 ppm/ $^{\circ}$ C Typical
- Temperature Compensated for operation over Full Rated Operating Temperature Range
- Low Output Noise Voltage

CIRCUIT SCHEMATIC

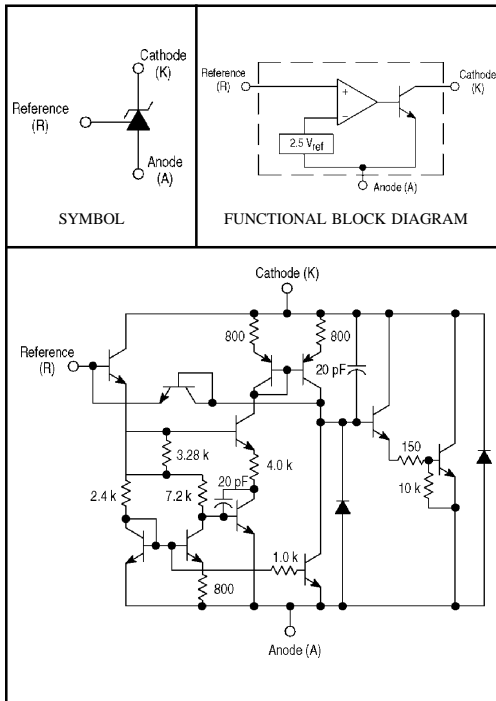

PIN ARRANGEMENT

TO-92

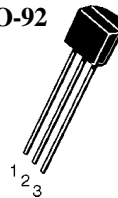

Pin: 1. Reference
2. Anode
3. Cathode

DIP-8

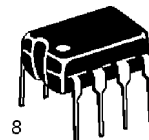

Pin: 1. Cathode
6. Anode
8. Reference
Other Pins: NC

SOP-8

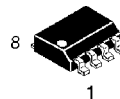

Pin: 1. Cathode 5. NC
2. Anode 6. Anode
3. Reference 7. Anode
4. NC 8. Reference

This SOP-8 is an internally modified SOP-8 Package. Pins 2, 3, 6 and 7 are electrically common to the die attach flag. This internal lead frame modification decreases package thermal resistance and increases power dissipation capability when appropriately mounted on a printed circuit board. This SOP-8 conforms to all external dimensions of the standard SOP-8 package.

ORDERING INFORMATION

Device	Temperature Range	Package
TL431CT	0 to +70 $^{\circ}$ C	TO-92
TL431CD		DIP-8
TL431CS		SOP-8
TL431IT	-40 to +85 $^{\circ}$ C	TO-92
TL431ID		DIP-8
TL431IS		SOP-8

MAXIMUM RATINGS (Full operating ambient temperature range applies unless otherwise noted.)

Rating	Symbol	Value	Unit
Cathode to Anode Voltage	V_{KA}	37	V
Cathode Current Range, Continuous	I_K	-100 to +150	mA
Reference Input Current Range, Continuous	I_{ref}	-0.05 to +10	mA
Operating Junction Temperature	T_J	150	°C
Operating Ambient Temperature Range TL431I, TL431AI, TL431BI TL431C, TL431AC, TL431BC	T_A	-40 to +85 0 to +70	°C
Storage Temperature Range	T_{stg}	-65 to +150	°C
Total Power Dissipation @ $T_A = 25^\circ\text{C}$ Derate above $T_A = 25^\circ\text{C}$ Ambient Temperature T, S Suffix Packages D Suffix Package	P_D	0.70 1.10	W
Total Power Dissipation @ $T_C = 25^\circ\text{C}$ Derate above $T_A = 25^\circ\text{C}$ Case Temperature T, S Suffix Packages D Suffix Package	P_D	1.5 3.0	W

THERMAL CHARACTERISTICS

Characteristic	Symbol	T, S Suffix	D Suffix	Unit
Thermal Resistance, Junction to Ambient	$R_{\theta JA}$	178	114	°C/W
Thermal Resistance, Junction to Case	$R_{\theta JC}$	83	41	°C/W

RECOMMENDED OPERATING CONDITIONS

Condition / Value	Symbol	Min	Max	Unit
Thermal Resistance, Junction to Ambient	V_{KA}	Vref	36	V
Thermal Resistance, Junction to Case	I_K	1.0	100	mA

ELECTRICAL CHARACTERISTICS (Ambient temperature at 25°C unless otherwise noted)

Characteristic	Symbol	TL431I			TL431C			Unit
		Min	Typ	Max	Min	Typ	Max	
Reference Input Voltage (Fig. 1) $V_{KA} = V_{ref}$, $I_K = 10\text{mA}$ $T_A = 25^\circ\text{C}$ $T_A = T_{low}$ to T_{high} (Note 1)	V_{ref}	2.44 2.41	2.495 ---	2.55 2.58	2.44 2.423	2.495 ---	2.55 2.567	V
Reference Input Voltage Deviation Over Temperature Range (Fig. 1, Note 1, 2, 4) $V_{KA} = V_{ref}$, $I_K = 10\text{mA}$	ΔV_{ref}	---	7.0	30	---	3.0	17	mV
Ratio of Change in Reference Input Voltage to Change in Cathode to Anode Voltage $I_K = 10\text{mA}$ (Fig. 2), $\Delta V_{KA} = 10\text{V}$ to V_{ref} $\Delta V_{KA} = 36\text{V}$ to 10V	$\frac{\Delta V_{ref}}{\Delta V_{KA}}$	---	-1.4 -1.0	-2.7 -2.0	---	-1.4 -1.0	-2.7 -2.0	mV/V
Reference Input Current (Fig. 2) $I_K = 10\text{mA}$, $R1 = 10\text{k}$, $R2 = \infty$ $T_A = 25^\circ\text{C}$ $T_A = T_{low}$ to T_{high} (Note 1)	I_{ref}	---	1.8 ---	4.0 6.5	---	1.8 ---	4.0 5.2	μA
Reference Input Current Deviation Over Temperature Range (Fig. 2, Note 1, 4) $I_K = 10\text{mA}$, $R1 = 10\text{k}$, $R2 = \infty$	ΔI_{ref}	---	0.8	2.5	---	0.4	1.2	μA
Minimum Cathode Current for Regulation $V_{KA} = V_{ref}$ (Fig. 1)	I_{min}	---	0.5	1.0	---	0.5	1.0	mA
Off - State Cathode Current (Fig. 3) $V_{KA} = 36\text{V}$, $V_{ref} = 0\text{V}$	I_{off}	---	260	1000	---	2.6	1000	nA
Dynamic Impedance (Fig. 1, Note 3) $V_{KA} = V_{ref}$, $\Delta I_K = 1.0\text{mA}$ to 100mA , $f \leq 1.0\text{ kHz}$	$ Z_{KA} $	---	0.22	0.5	---	0.22	0.5	Ω

ELECTRICAL CHARACTERISTICS (Ambient temperature at 25°C unless otherwise noted)

Characteristic	Symbol	TL431AI			TL431AC			TL431B			Unit
		Min	Typ	Max	Min	Typ	Max	Min	Typ	Max	
Reference Input Voltage (Fig. 1) $V_{KA} = V_{ref}$, $I_K = 10\text{mA}$ $T_A = 25^\circ\text{C}$ $T_A = T_{low}$ to T_{high} (Note 1)	V_{ref}	2.47 2.44	2.495 ---	2.52 2.55	2.47 2.453	2.495 ---	2.52 2.537	2.483 2.475	2.495 2.495	2.507 2.515	V
Reference Input Voltage Deviation Over Temperature Range (Fig. 1, Note 1, 2, 4) $V_{KA} = V_{ref}$, $I_K = 10\text{mA}$	ΔV_{ref}	---	7.0	30	---	3.0	17	---	3.0	17	mV
Ratio of Change in Reference Input Voltage to Change in Cathode to Anode Voltage $I_K = 10\text{mA}$ (Fig. 2), $\Delta V_{KA} = 10\text{V}$ to V_{ref} $\Delta V_{KA} = 36\text{V}$ to 10V	$\frac{\Delta V_{ref}}{\Delta V_{KA}}$	---	-1.4 -1.0	-2.7 -2.0	---	-1.4 -1.0	-2.7 -2.0	---	-1.4 -1.0	-2.7 -2.0	mV/V
Reference Input Current (Fig. 2) $I_K = 10\text{mA}$, $R1 = 10\text{k}$, $R2 = \infty$ $T_A = 25^\circ\text{C}$ $T_A = T_{low}$ to T_{high} (Note 1)	I_{ref}	---	1.8 ---	4.0 6.5	---	1.8 ---	4.0 5.2	---	1.1 ---	2.0 4.0	μA
Reference Input Current Deviation Over Temperature Range (Fig. 2, Note 1, 4) $I_K = 10\text{mA}$, $R1 = 10\text{k}$, $R2 = \infty$	ΔI_{ref}	---	0.8	2.5	---	0.4	1.2	---	0.4	1.2	μA
Minimum Cathode Current for Regulation $V_{KA} = V_{ref}$ (Fig. 1)	I_{min}	---	0.5	1.0	---	0.5	1.0	---	0.5	1.0	mA
Off - State Cathode Current (Fig. 3) $V_{KA} = 36\text{V}$, $V_{ref} = 0\text{V}$	I_{off}	---	260	1000	---	260	1000	---	230	500	nA
Dynamic Impedance (Fig. 1, Note 3) $V_{KA} = V_{ref}$, $\Delta I_K = 1.0\text{mA}$ to 100mA , $f \leq 1.0\text{ kHz}$	$ Z_{KA} $	---	0.22	0.5	---	0.22	0.5	---	0.14	0.3	Ω

1

$T_{low} = 0^{\circ}C$, $T_{high} = +70^{\circ}C$

2

The deviation parameter ΔV_{ref} is defined as the differences between the maximum and minimum values obtained over the full operating ambient temperature range the applies.

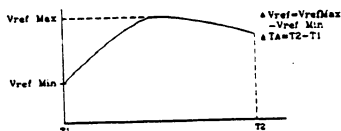

The average temperature coefficient of the reference input voltage, αV_{ref} , is defined as :

$$\alpha V_{ref} \frac{ppm}{^{\circ}C} = \frac{\left(\frac{\Delta V_{ref}}{V_{ref @ 25^{\circ}C}} \right) \times 10^6}{\Delta T_A} = \frac{\Delta V_{ref} \times 10^6}{\Delta T_A (V_{ref @ 25^{\circ}C})}$$

αV_{ref} can be positive or negative depending on whether $V_{ref Min}$ or $V_{ref Max}$ occurs at the lower ambient temperature. (Refer to Figure 6)

Example: $\Delta V_{ref} = 8.0 \text{ mV}$ and slope is positive, $V_{ref @ 25^{\circ}C} = 2.495V$, $\Delta T_A = 70^{\circ}C$

$$\alpha V_{ref} = \frac{0.008 \times 10^6}{70(2.495)} = 45.8 \text{ ppm}/^{\circ}C$$

3

The dynamic impedance Z_{ka} is defined as:

$$|Z_{ka}| = \frac{\Delta V_{KA}}{\Delta I_K}$$

When the device is programmed with two external resistors, R1 and R2, (refer to Figure 2) the total dynamic impedance of the circuit is defined as:

$$|Z_{ka}| \approx |Z_{ka}| \left(1 + \frac{R1}{R2} \right)$$

4

This test is not applicable to surface mount (D suffix) devices.

FIGURE 1 -- TEST CIRCUIT FOR $V_{KA} = V_{ref}$

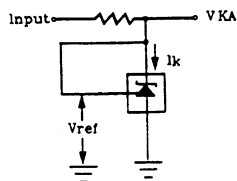
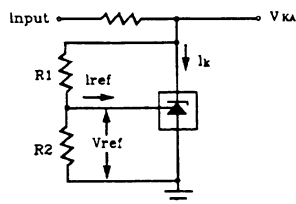

FIGURE 2 -- TEST CIRCUIT FOR $V_{KA} > V_{ref}$



$$V_{KA} = V_{ref} \left(1 + \frac{R1}{R2} \right) + I_{ref} \cdot R1$$

FIGURE 3 -- TEST CIRCUIT FOR I_{off}

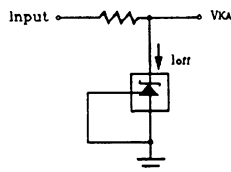

FIGURE 4 - CATHODE CURRENT VERSUS CATHODE VOLTAGE

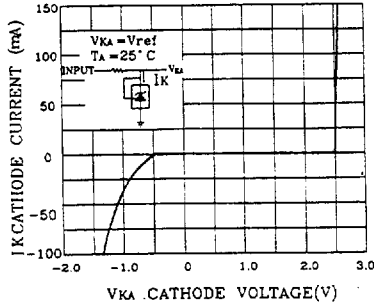

FIGURE 5 - CATHODE CURRENT VERSUS CATHODE VOLTAGE

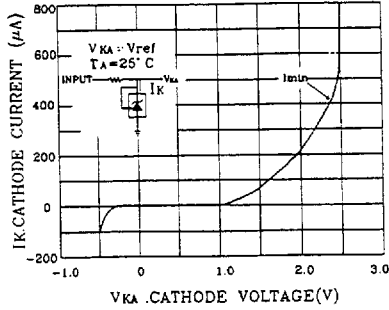

FIGURE 6 - REFERENCE INPUT VOLTAGE VERSUS AMBIENT TEMPERATURE

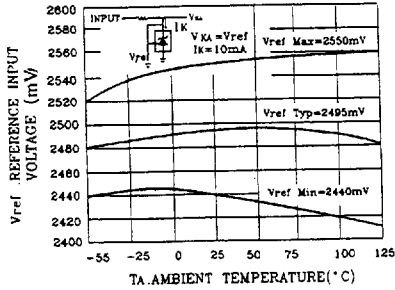

FIGURE 7 - REFERENCE INPUT CURRENT VERSUS AMBIENT TEMPERATURE

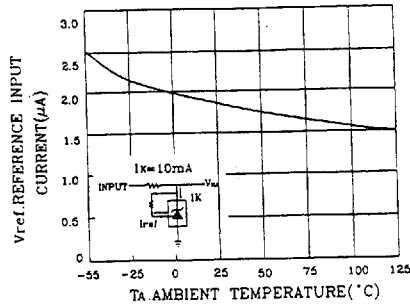

FIGURE 8 - CHANGE IN REFERENCE INPUT VOLTAGE VERSUS CATHODE VOLTAGE

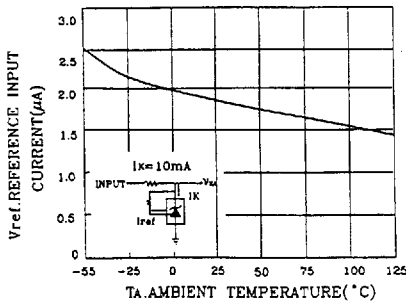

FIGURE 9 - OFF-STATE CATHODE CURRENT VERSUS AMBIENT TEMPERATURE

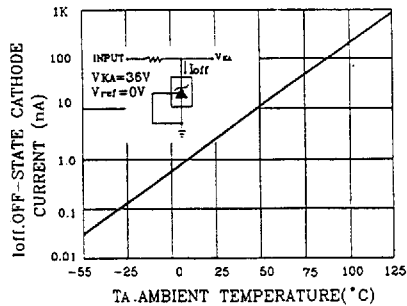

FIGURE 10 - DYNAMIC IMPEDANCE VERSUS FREQUENCY

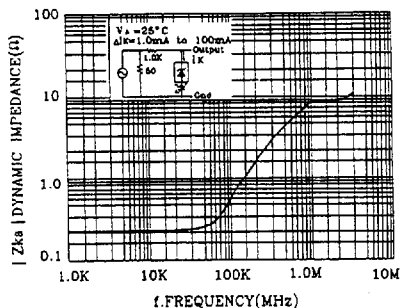

FIGURE 11 - DYNAMIC IMPEDANCE VERSUS AMBIENT TEMPERATURE

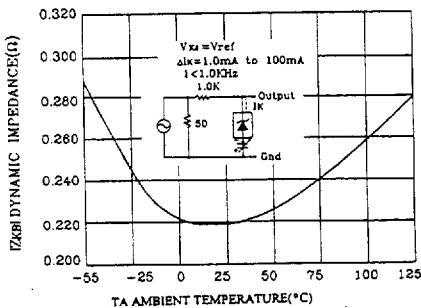

FIGURE 12 - OPEN LOOP VOLTAGE GAIN VERSUS FREQUENCY

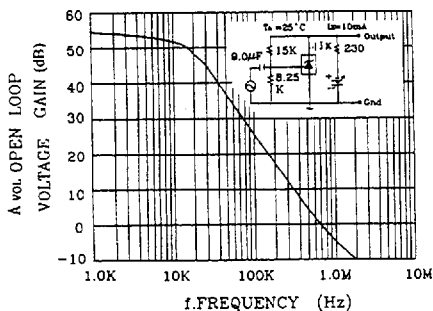

FIGURE 13 - SPECTRAL NOISE DENSITY

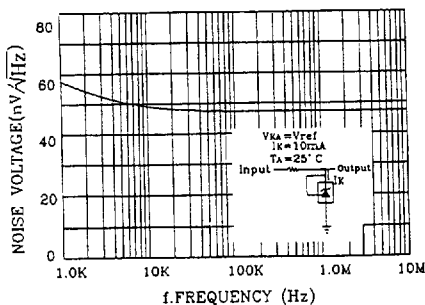

FIGURE 14 - PULSE RESPONSE

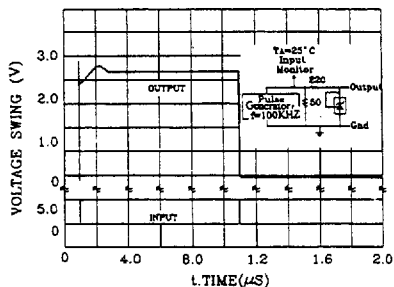

FIGURE 15 - STABILITY BOUNDARY CONDITIONS

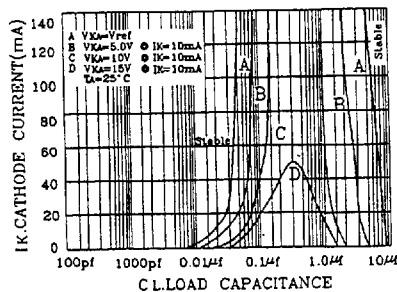

FIGURE 16-TEST CIRCUIT FOR CURVE A OF STABILITY BOUNDARY CONDITIONS

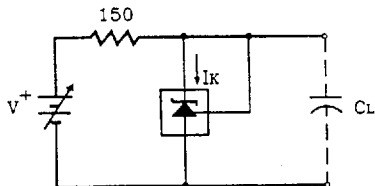
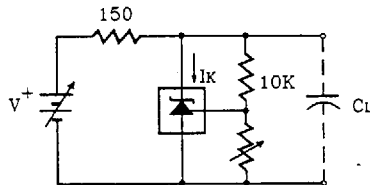
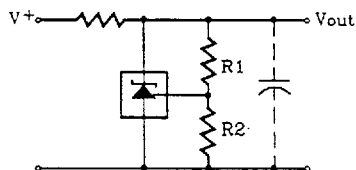

FIGURE 17-TEST CIRCUIT FOR CURVES B.C. AND D OF STABILITY BOUNDARY CONDITIONS



TYPICAL APPLICATIONS

FIGURE 18-SHUNT REGULATOR



$$V_{out} = \left(1 + \frac{R1}{R2}\right) V_{ref}$$

FIGURE 19-HIGH CURRENT SHUNT REGULATOR

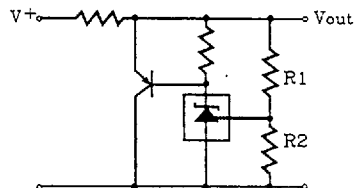

$$V_{out} = \left(1 + \frac{R1}{R2}\right) V_{ref}$$

FIGURE 20-OUTPUT CONTROL OF A THREE-TERMINAL FIXED REGULATOR

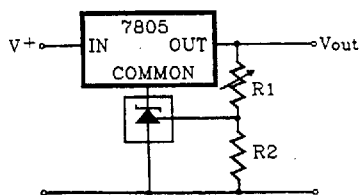

$$V_{out} = \left(1 + \frac{R1}{R2}\right) V_{ref}$$

$$V_{out_{min}} = V_{ref} + 5.0V$$

FIGURE 21-SERIES PASS REGULATOR

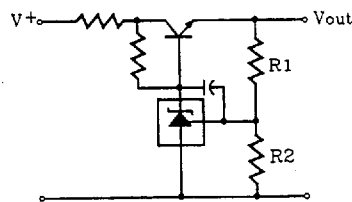

$$V_{out} = \left(1 + \frac{R1}{R2}\right) V_{ref}$$

$$V_{out_{min}} = V_{ref} + V_{BE}$$

FIGURE 22-CONSTANT CURRENT SOURCE

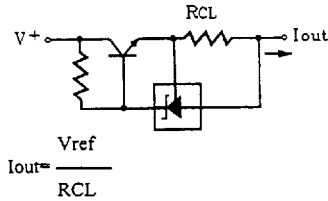
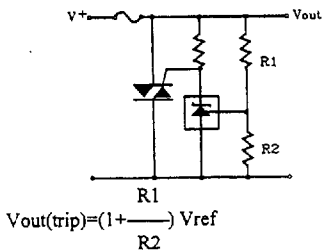
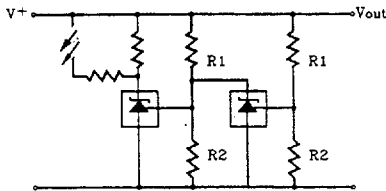

FIGURE 24-TRIAC CROWBAR



$$V_{out(trip)} = \left(1 + \frac{R1}{R2}\right) V_{ref}$$

FIGURE 26-VOLTAGE MONITOR



L.E.D. indicator is "on" when V+ is between the upper and lower limits.

$$\text{Lower Limit} = \left(1 + \frac{R1}{R2}\right) V_{ref} \quad \text{Upper Limit} = \left(1 + \frac{R3}{R4}\right) V_{ref}$$

FIGURE 28-LINER OHMMETER

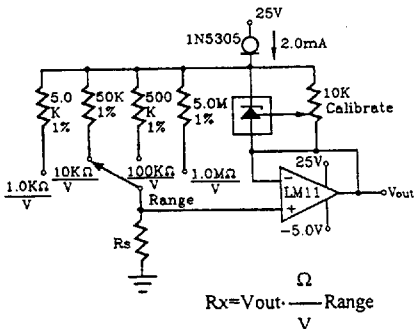

$$R_x = V_{out} \cdot \frac{\Omega}{V} \cdot \text{Range}$$

FIGURE 23-CONSTANT CURRENT SINK

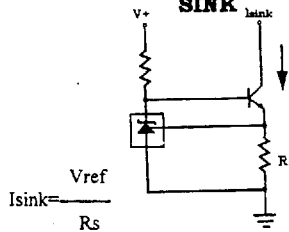
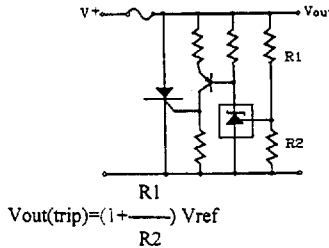

FIGURE 25-SCR CROWBAR



$$V_{out(trip)} = \left(1 + \frac{R1}{R2}\right) V_{ref}$$

FIGURE 27-SINGLE-SUPPLY COMPARATOR WITH TEMPERATURE-COMPENSATED THRESHOLD

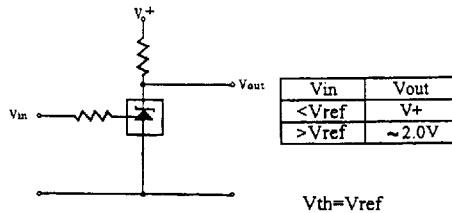

FIGURE 29-SIMPLE 400mW PHONO AMPLIFIER

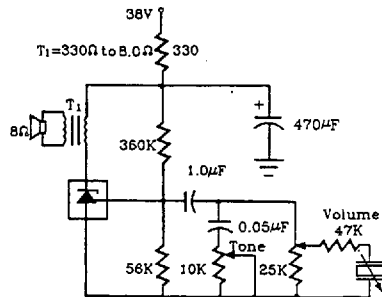
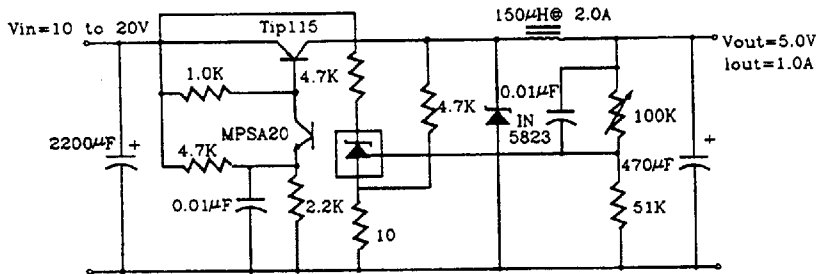

FIGURE 30-HIGH EFFICIENCY STEP-DOWN SWITCHING CONVERTER



TEST	CONDITIONS	RESULTS
Line Regulation	$V_{in}=10V$ to $20V$, $I_o=1.0A$	53mV (1.1%)
Load Regulation	$V_{in}=15V$, $I_o=0A$ to $1.0A$	25mV (0.5%)
Output Ripple	$V_{in}=10V$, $I_o=1.0A$	50mVp-p P.A.R.D.
Output Ripple	$V_{in}=20V$, $I_o=1.0A$	100mVp-p P.A.R.D.
Efficiency	$V_{in}=15V$, $I_o=1.0A$	82%