



TL072

LINEAR INTEGRATED CIRCUIT

LOW NOISE DUAL J-FET OPERATIONAL AMPLIFIER

DESCRIPTION

The UTC TL072 is a high speed J-FET input dual operational amplifier. It incorporates well matched, high voltage J-FET and bipolar transistors in a monolithic integrated circuit. The device features high slew rates, low input bias and offset current, and low offset voltage temperature coefficient.

FEATURES

- *Low power consumption
- *Wide common-mode (up to V_{CC+}) and differential voltage range
- *Low input bias and offset current
- *Low noise $e_n = 15nV / \sqrt{Hz}$ (typ)
- *Output short-circuit protection
- *High input impedance J-FET input stage
- *Low harmonic distortion:0.01%(typ)
- *Internal frequency compensation
- *Latch up free operation
- *High slewrate:16V/ μs (typ)

ORDERING INFORMATION

Order Number		Package	Packing
Normal	Lead Free Plating		
TL072-D08-T	TL072L-D08-T	DIP-8	Tube
TL072-P08-R	TL072L-P08-R	TSSOP-8	Tape Reel
TL072-P08-T	TL072L-P08-T	TSSOP-8	Tube
TL072-S08-R	TL072L-S08-R	SOP-8	Tape Reel
TL072-S08-T	TL072L-S08-T	SOP-8	Tube

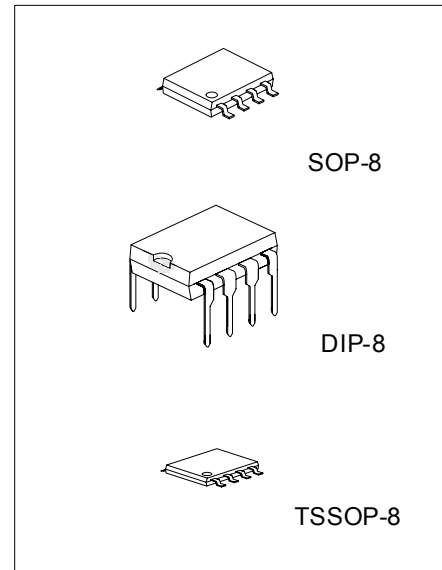

*Pb-free plating product number: TL072L

<p>TL072L-D08-T</p> <p>(1)Packing Type (2)Package Type (3)Lead Plating</p>	<p>(1) R: Tape Reel, T: Tube (2) D08: DIP-8, P08: TSSOP-8, S08: SOP-8 (3) L: Lead Free Plating Blank: Pb/Sn</p>
--	---

■ PIN CONFIGURATIONS

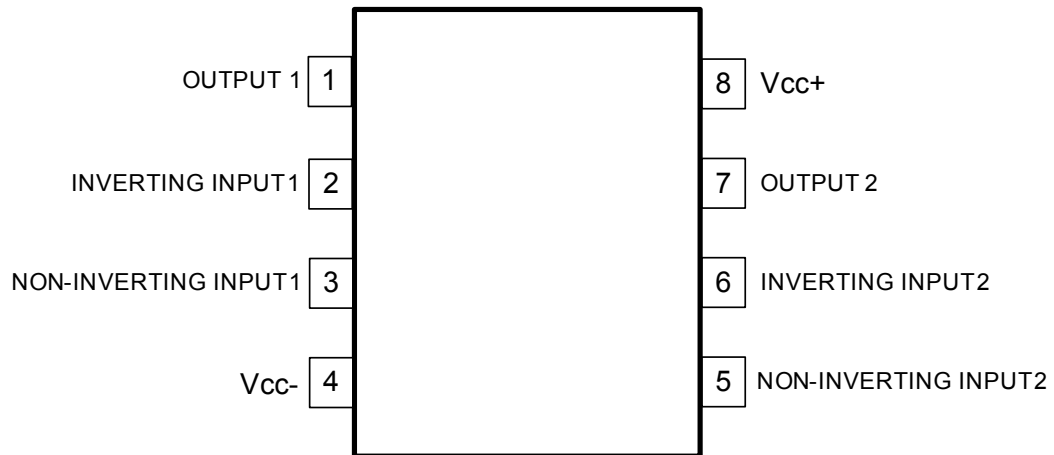

■ BLOCK DIAGRAM

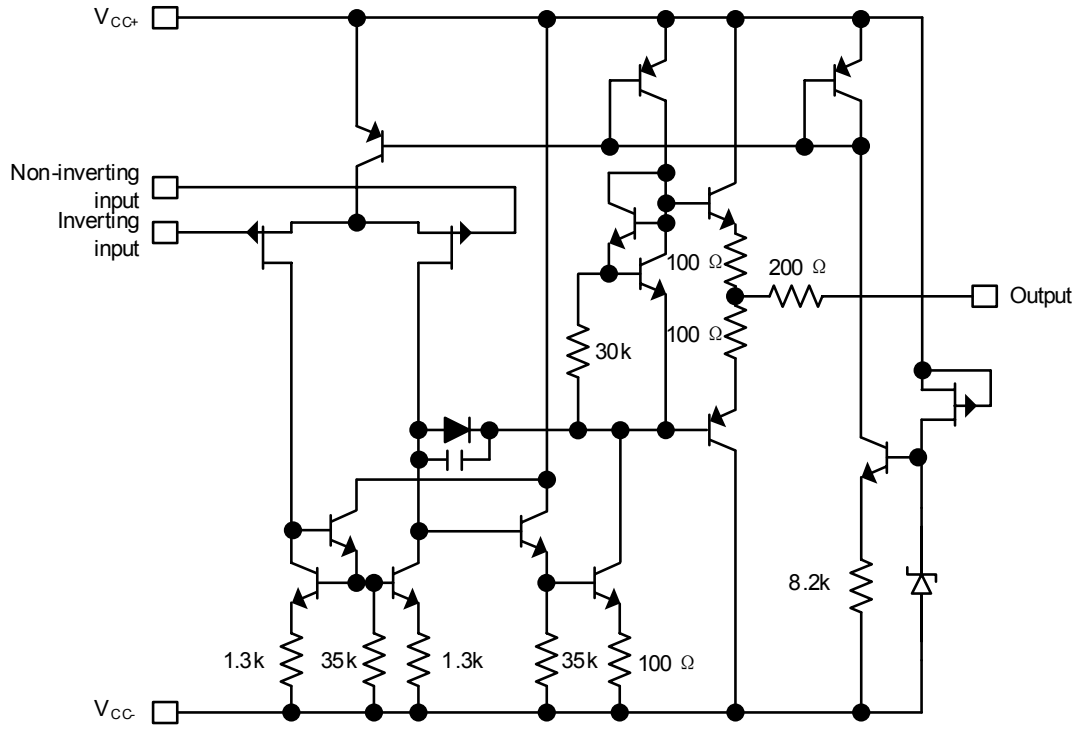

■ ABSOLUTE MAXIMUM RATINGS (Ta=25°C)

PARAMETER	SYMBOL	RATINGS	UNIT
Supply Voltage (note 1)	V _{CC}	±18	V
Input Voltage (note 2)	V _{IN}	±15	V
Differential Input Voltage (note 3)	V _{I(DIFF)}	±30	V
Power Dissipation	P _D	680	mW
Output Short-Circuit Duration (Note 4)		Infinite	
Operating Temperature	T _{OPR}	0 ~ +70	°C
Storage Temperature	T _{STG}	-65 ~ +150	°C

Notes: 1. All voltage values, except differential voltage, are with respect to the zero reference level (ground) of the supply voltages where the zero reference level is the midpoint between V_{CC-} and V_{CC+}.

2. The magnitude of the input voltage must never exceed the magnitude of the supply voltage or 15 volts, whichever is less.
3. Differential voltages are at the non-inverting input terminal with respect to the inverting input terminal.
4. The output may be shorted to ground or to either supply. Temperature and/or supply voltages must be limited to ensure that the dissipation rating is not exceeded.
5. Absolute maximum ratings are those values beyond which the device could be permanently damaged. Absolute maximum ratings are stress ratings only and functional device operation is not implied.

■ UTC TL072 C ELECTRICAL CHARACTERISTICS

($V_{CC}=\pm 15V$, $T_a=25^\circ C$, $T_{MIN}=0^\circ C$, $T_{MAX}=70^\circ C$, unless otherwise specified)

PARAMETER	SYMBOL	CONDITIONS		MIN	TYP	MAX	UNIT
Input Offset Voltage	$V_{I(OFF)}$	$R_S=50\Omega$	$T_a=25^\circ C$		3	10	mV
			$T_{MIN} \leq T_a \leq T_{MAX}$			13	mV
Temperature Coefficient of Input Offset Voltage	D_{vio}	$R_S=50\Omega$			10		$\mu V/^\circ C$
Input Offset Current*	$I_{I(OFF)}$	$T_a=25^\circ C$			5	100	pA
		$T_{MIN} \leq T_a \leq T_{MAX}$				10	nA
Input Bias Current*	$I_{I(BIAS)}$	$T_a=25^\circ C$			20	200	pA
		$T_{MIN} \leq T_a \leq T_{MAX}$				20	nA
Input Common Mode Voltage	$V_{I(COM)}$			± 11	-12~+15		V
Output Voltage Swing	V_{OPP}	$R_L=10k\Omega$	$T_a=25^\circ C, R_L=2k\Omega$	10	12		V
			$T_a=25^\circ C, R_L=10k\Omega$	12	13.5		v
			$T_{MIN} \leq T_a \leq T_{MAX}, R_L=2k\Omega$	10			V
			$T_{MIN} \leq T_a \leq T_{MAX}, R_L=10k\Omega$	12			V
Large Signal Voltage Gain	A_{vd}	$R_L=10k\Omega, V_{OUT}=\pm 10V$	$T_a=25^\circ C$	25	200		V/mV
			$T_{MIN} \leq T_a \leq T_{MAX}$	15			V/mV
Gain Bandwidth Product	GB_W	$T_a=25^\circ C, R_L=10k\Omega, C_L=100pF$		2.5	4		MHz
Input Resistance	R_{IN}				10^{12}		Ω
Common Mode Rejection Ratio	CMR	$R_S=50\Omega$	$T_a=25^\circ C$	70	86		dB
			$T_{MIN} \leq T_a \leq T_{MAX}$	70			dB
Supply Voltage Rejection Ratio	SVR	$R_S=50\Omega$	$T_a=25^\circ C$	70	86		dB
			$T_{MIN} \leq T_a \leq T_{MAX}$	70			dB
Supply Current	I_{CC}	no load	$T_a=25^\circ C$		1.4	2.5	mA
			$T_{MIN} \leq T_a \leq T_{MAX}$			2.5	mA
Channel Separation	V_{01}/V_{02}	$A_v=100, T_a=25^\circ C$			120		dB
Output Short-circuit Current	I_{OS}	$T_a=25^\circ C$		10	40	60	mA
		$T_{MIN} \leq T_a \leq T_{MAX}$		10		60	mA
Slew Rate	SR	$V_{IN}=10V, R_L=2k\Omega, C_L=100pF, T_a=25^\circ C, \text{unity gain}$		8	16		V/ μs
Rise Time	t_R	$V_{IN}=20mV, R_L=2k\Omega, C_L=100pF, T_a=25^\circ C, \text{unity gain}$			0.1		μs
Overshoot Factor	K_{ov}	$V_{IN}=20mV, R_L=2k\Omega, C_L=100pF, T_a=25^\circ C, \text{unity gain}$			10		%
Total Harmonic Distortion	THD	$A_v=20dB, f=1kHz, R_L=2k\Omega, C_L=100pF, T_a=25^\circ C, V_{OUT}=2V_{pp}$			0.01		%
Phase Margin	ϕ_m				45		Degrees
Equivalent Input Noise Voltage	eN	$R_S=100\Omega, f=1KHz$			15		$\frac{nV}{\sqrt{Hz}}$

*The Input bias currents are junction leakage currents, which approximately double for every $10^\circ C$ increase in the junction temperature.

■ UTC TL072 AC ELECTRICAL CHARACTERISTICS

($V_{CC}=\pm 15V$, $T_a=25^\circ C$, $T_{MIN}=0^\circ C$, $T_{MAX}=70^\circ C$, unless otherwise specified)

PARAMETER	SYMBOL	CONDITIONS		MIN	TYP	MAX	UNIT
Input Offset Voltage	$V_{I(OFF)}$	$R_S=50\Omega$	$T_a=25^\circ C$		3	6	mV
			$T_{MIN} \leq T_a \leq T_{MAX}$			7	mV
Temperature Coefficient of Input Offset Voltage	D_{vio}	$R_S=50\Omega$			10		$\mu V/^\circ C$
Input Offset Current*	$I_{I(OFF)}$		$T_a=25^\circ C$		5	100	pA
			$T_{MIN} \leq T_a \leq T_{MAX}$			4	nA
Input Bias Current*	$I_{I(BIAS)}$		$T_a=25^\circ C$		20	200	pA
			$T_{MIN} \leq T_a \leq T_{MAX}$			20	nA
Input Common Mode Voltage	$V_{I(COM)}$			± 11	$-12 \sim +15$		V
Output Voltage Swing	V_{OPP}	$R_L=10k\Omega$	$T_a=25^\circ C, R_L=2k\Omega$	10	12		V
			$T_a=25^\circ C, R_L=10k\Omega$	12	13.5		V
			$T_{MIN} \leq T_a \leq T_{MAX}, R_L=2k\Omega$	10			V
			$T_{MIN} \leq T_a \leq T_{MAX}, R_L=10k\Omega$	12			V
Large Signal Voltage Gain	A_{vd}	$R_L=10k\Omega, V_{OUT}=\pm 10V$	$T_a=25^\circ C$	50	200		V/mV
			$T_{MIN} \leq T_a \leq T_{MAX}$	25			V/mV
Gain Bandwidth Product	GB_W	$T_a=25^\circ C, R_L=10k\Omega, C_L=100pF$		2.5	4		MHz
Input Resistance	R_{IN}				10^{12}		Ω
Common Mode Rejection Ratio	CMR	$R_S=50\Omega$	$T_a=25^\circ C$	80	86		dB
			$T_{MIN} \leq T_a \leq T_{MAX}$	80			dB
Supply Voltage Rejection Ratio	SVR	$R_S=50\Omega$	$T_a=25^\circ C$	80	86		dB
			$T_{MIN} \leq T_a \leq T_{MAX}$	80			dB
Supply Current (no load)	I_{CC}		$T_a=25^\circ C$		1.4	2.5	mA
			$T_{MIN} \leq T_a \leq T_{MAX}$			2.5	mA
Channel Separation	V_{01}/V_{02}	$(A_v=100, T_a=25^\circ C)$			120		dB
Output Short-circuit Current	I_{OS}		$T_a=25^\circ C$	10	40	60	mA
			$T_{MIN} \leq T_a \leq T_{MAX}$	10		60	mA
Slew Rate	SR	$V_{IN}=10V, R_L=2k\Omega, C_L=100pF, T_a=25^\circ C,$ unity gain		8	16		V/ μs
Rise Time	t_R	$V_{IN}=20mV, R_L=2k\Omega, C_L=100pF, T_a=25^\circ C,$ unity gain			0.1		μs
Overshoot Factor	K_{ov}	$V_{IN}=20mV, R_L=2k\Omega, C_L=100pF, T_a=25^\circ C,$ unity gain			10		%
Total Harmonic Distortion	THD	$A_v=20dB, f=1kHz, R_L=2k\Omega, C_L=100pF,$ $T_a=25^\circ C, V_{OUT}=2V_{pp}$			0.01		%
Phase Margin	ϕ_m				45		Degrees
Equivalent Input Noise Voltage	e_N	$R_S=100\Omega, f=1KHz$			15		$\frac{nV}{\sqrt{Hz}}$

*The Input bias currents are junction leakage currents, which approximately double for every $10^\circ C$ increase in the junction temperature.

■ UTC TL072 BC ELECTRICAL CHARACTERISTICS

($V_{CC}=\pm 15V$, $T_a=25^\circ C$, $T_{MIN}=0^\circ C$, $T_{MAX}=70^\circ C$, unless otherwise specified unless otherwise specified)

PARAMETER	SYMBOL	CONDITIONS		MIN	TYP	MAX	UNIT
Input Offset Voltage	$V_{I(OFF)}$	$R_S=50\Omega$	$T_a=25^\circ C$		1	3	mV
			$T_{MIN} \leq T_a \leq T_{MAX}$			5	mV
Temperature Coefficient of Input Offset Voltage	D_{vio}	$R_S=50\Omega$			10		$\mu V/^\circ C$
Input Offset Current*	$I_{I(OFF)}$		$T_a=25^\circ C$		5	100	pA
			$T_{MIN} \leq T_a \leq T_{MAX}$			4	nA
Input Bias Current*	$I_{I(BIAS)}$		$T_a=25^\circ C$		20	200	pA
			$T_{MIN} \leq T_a \leq T_{MAX}$			20	nA
Input Common Mode Voltage	$V_{I(COM)}$			± 11	-12~+15		V
Output Voltage Swing	V_{OPP}	$R_L=10k\Omega$	$T_a=25^\circ C, R_L=2k\Omega$	10	12		V
			$T_a=25^\circ C, R_L=10k\Omega$	12	13.5		V
			$T_{MIN} \leq T_a \leq T_{MAX}, R_L=2k\Omega$	10			V
			$T_{MIN} \leq T_a \leq T_{MAX}, R_L=10k\Omega$	12			V
Large Signal Voltage Gain	A _{vd}	$R_L=10k\Omega, V_{OUT}=\pm 10V$	$T_a=25^\circ C$	50	200		V/mV
			$T_{MIN} \leq T_a \leq T_{MAX}$	25			V/mV
Gain Bandwidth Product	GB _W	$T_a=25^\circ C, R_L=10k\Omega, C_L=100pF$		2.5	4		MHz
Input Resistance	R_{IN}				10^{12}		Ω
Common Mode Rejection Ratio	CMR	$R_S=50\Omega$	$T_a=25^\circ C$	80	86		dB
			$T_{MIN} \leq T_a \leq T_{MAX}$	80			dB
Supply Voltage Rejection Ratio	SVR	$R_S=50\Omega$	$T_a=25^\circ C$	80	86		dB
			$T_{MIN} \leq T_a \leq T_{MAX}$	80			dB
Supply Current	I_{CC}	no load	$T_a=25^\circ C$		1.4	2.5	mA
			$T_{MIN} \leq T_a \leq T_{MAX}$			2.5	mA
Channel Separation	V01/V02	(A _v =100, $T_a=25^\circ C$)			120		dB
Output Short-circuit Current	I _{os}		$T_a=25^\circ C$	10	40	60	mA
			$T_{MIN} \leq T_a \leq T_{MAX}$	10		60	mA
Slew Rate	SR	$V_{IN}=10V, R_L=2k\Omega, C_L=100pF, T_a=25^\circ C,$ unity gain		8	16		V/ μs
Rise Time	t _r	$V_{IN}=20mV, R_L=2k\Omega, C_L=100pF, T_a=25^\circ C,$ unity gain			0.1		μs
Overshoot Factor	K _{ov}	$V_{IN}=20mV, R_L=2k\Omega, C_L=100pF, T_a=25^\circ C,$ unity gain			10		%
Total Harmonic Distortion	THD	A _v =20dB, f=1kHz, $R_L=2k\Omega, C_L=100pF,$ $T_a=25^\circ C, V_{OUT}=2V_{pp}$			0.01		%
Phase Margin	ϕ_m				45		Degrees
Equivalent Input Noise Voltage	e _N	$R_S=100\Omega, f=1KHz$			15		$\frac{nV}{\sqrt{Hz}}$

*The Input bias currents are junction leakage currents, which approximately double for every 10°C increase in the junction temperature.

■ PARAMETER MEASUREMENT INFORMATION

Figure 1. Voltage Follower

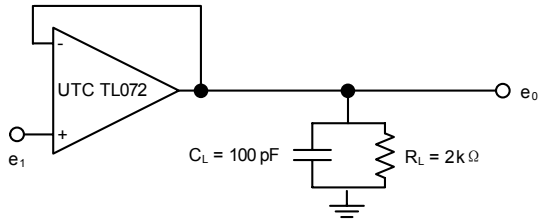
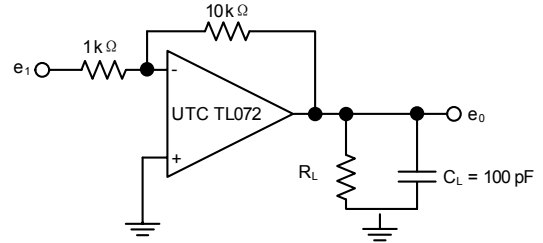
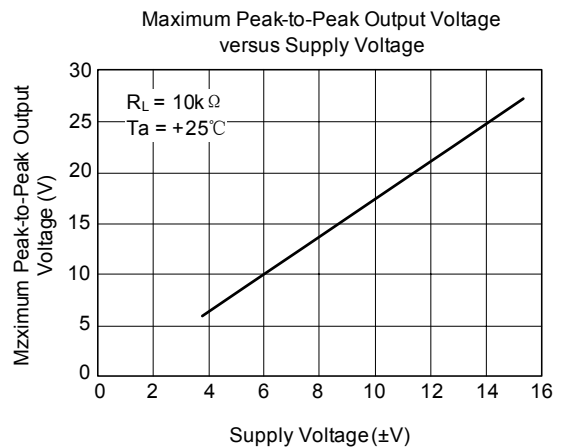
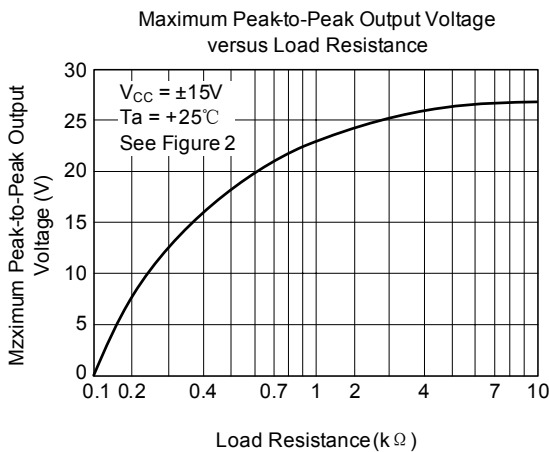
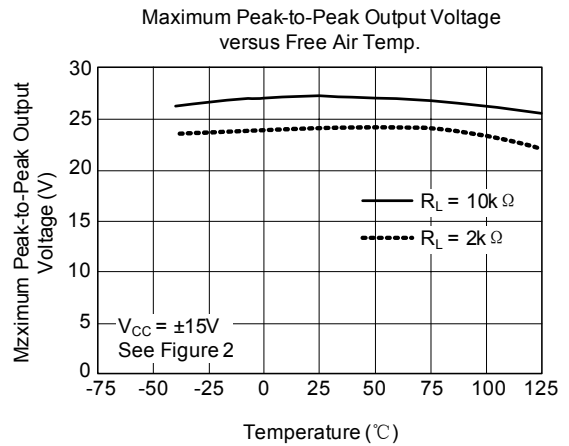
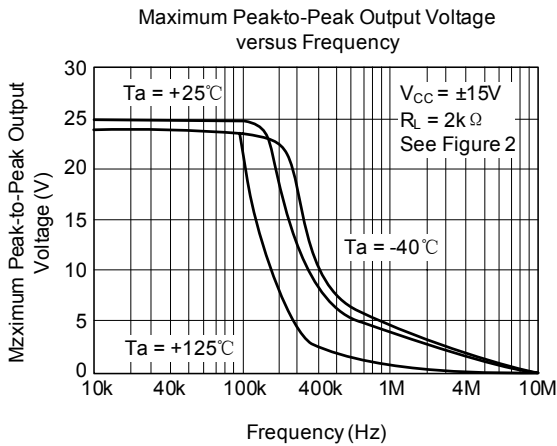
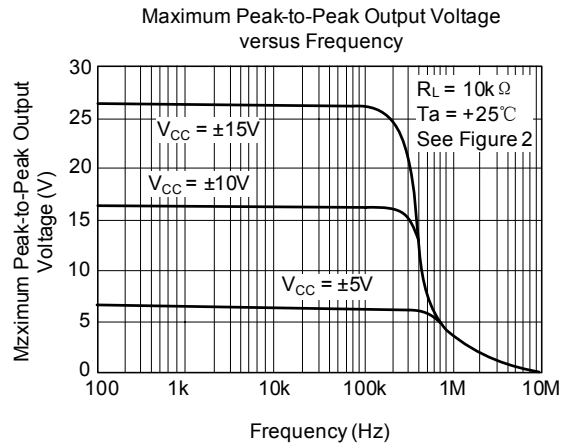
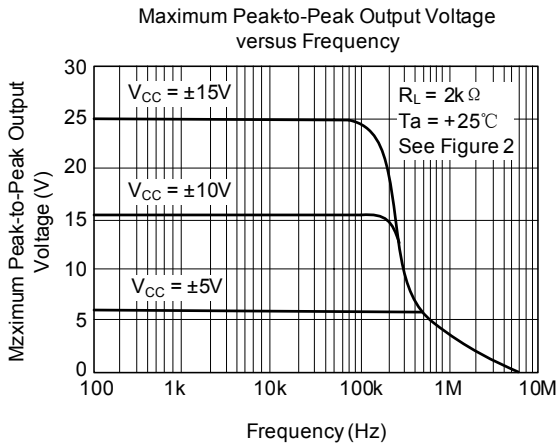

Figure 2. Gain-of-10 Inverting Amplifier



TYPICAL CHARACTERISTICS



■ TYPICAL CHARACTERISTICS(Cont.)

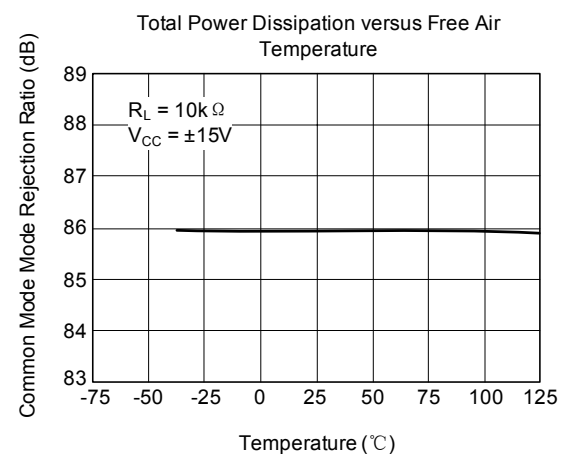
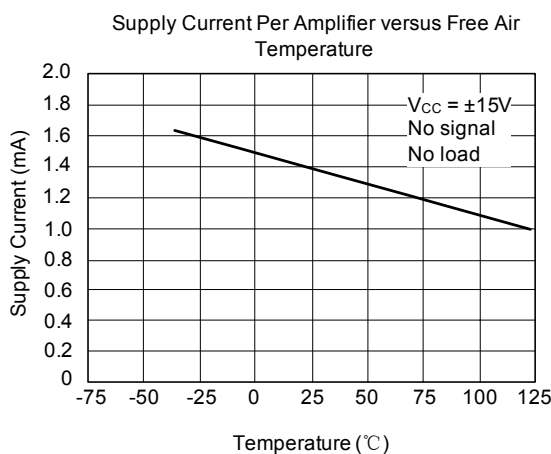
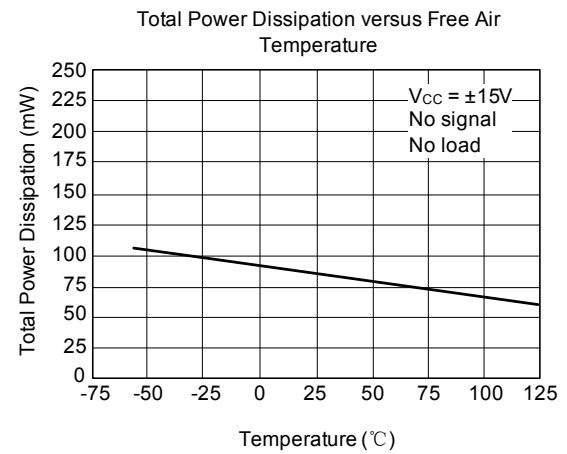
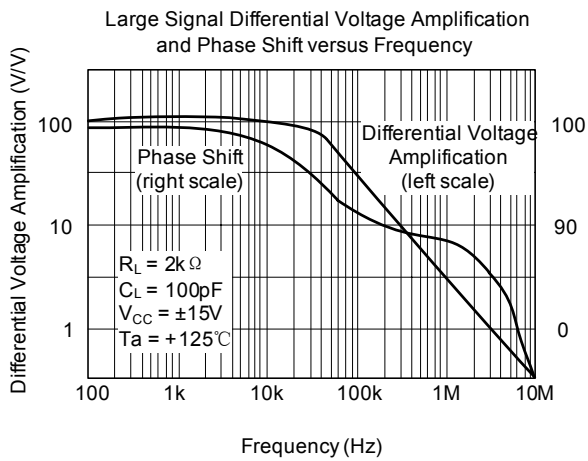
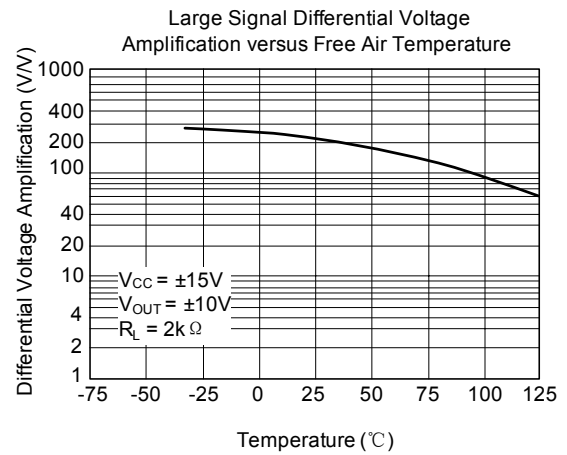
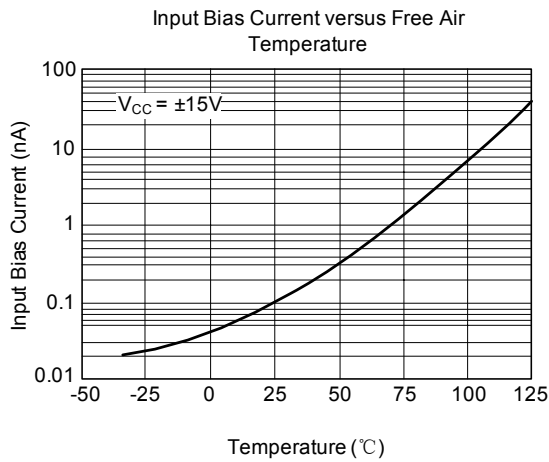

■ TYPICAL CHARACTERISTICS(Cont.)

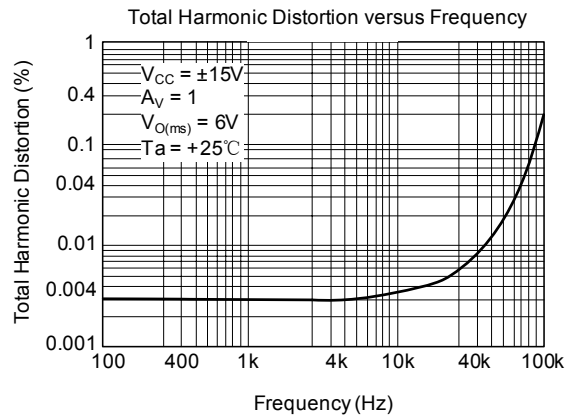
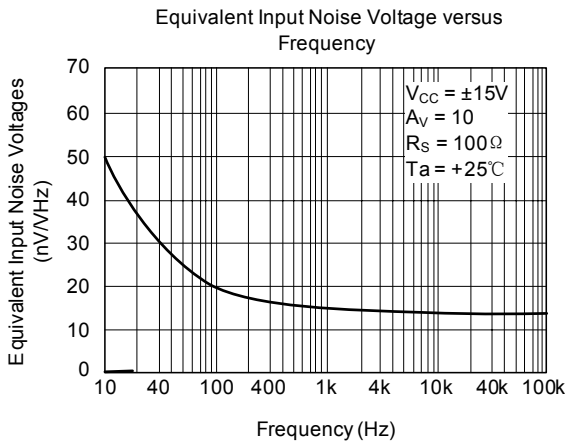
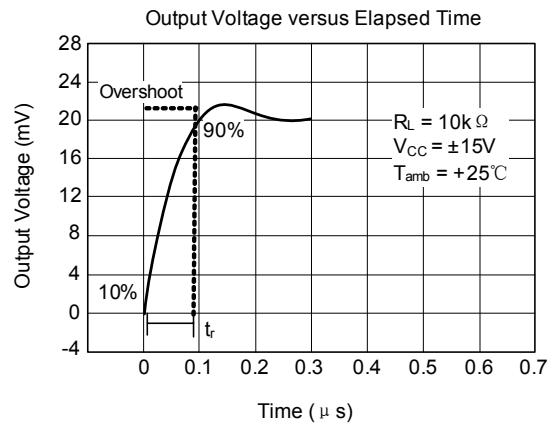
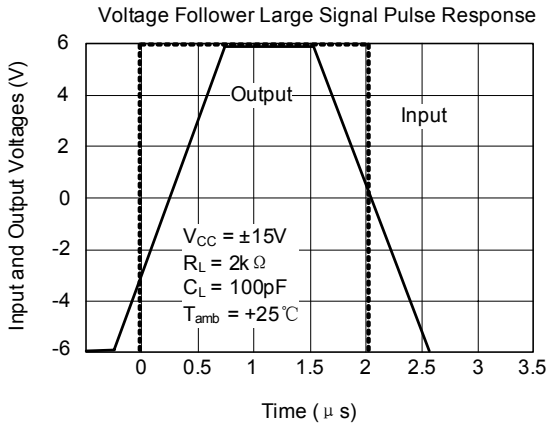

UTC assumes no responsibility for equipment failures that result from using products at values that exceed, even momentarily, rated values (such as maximum ratings, operating condition ranges, or other parameters) listed in products specifications of any and all UTC products described or contained herein. UTC products are not designed for use in life support appliances, devices or systems where malfunction of these products can be reasonably expected to result in personal injury. Reproduction in whole or in part is prohibited without the prior written consent of the copyright owner. The information presented in this document does not form part of any quotation or contract, is believed to be accurate and reliable and may be changed without notice.