

General Description

The EV0066 is a 20W stereo evaluation board featuring MPS' MP7720 Class D Single Ended Audio Amplifier. The EV0066 can deliver 20W into a 4Ω load with a 24V input supply.

The MP7720 is a mono 20W Class D Audio Amplifier. It is one of MPS's second generation of fully integrated audio amplifiers which dramatically reduces solution size by integrating the following:

- 180mΩ power MOSFETs
- Start up / shut down pop elimination
- Short circuit protection circuits

The MP7720 utilizes a single ended output structure capable of delivering 20W into 4Ω speakers. As in all other MPS Class D Audio Amplifiers, this device exhibits the high fidelity of a Class A/B amplifier at efficiencies greater than 90%.

Ordering Information

Board Number	MPS IC Number
EV0066	MP7720DS

EV0066 Evaluation Board



(Actual Size = 1.0"X x 1.4"Y)

Absolute Maximum Ratings

Supply Voltage V_{DD}	26V
Signal Input Voltage	±2V p-p
Enable Voltage	-0.3 to 6V

Recommended Operating Conditions

Input Voltage V_{DD}	7.5V to 24V
Signal Input Voltage	1V rms
Signal Input Frequency	20Hz to 20KHz
Signal Source Impedance	≤600Ω
External Enable Input	0V to 5V
Speaker Resistance	4Ω to 8Ω

Performance

Maximum Output Power (10% THD, 4Ω)	20W
Maximum Output Power (10% THD, 8Ω)	10W
THD (1kHz, 1W)	0.05%
Power Efficiency ($P_{OUT}=20W, 4Ω$)	90%

Features

- 20W Output at 24V Input Into a 4Ω Load
- 0.05% THD+N @ 2W, 1KHz Into 4Ω Load
- 0.05% THD+N @ 2W, 1KHz Into 8Ω Load
- 90% Efficiency at 20W
- Integrated Start-Up and Shut-Down Pop Elimination Circuit
- Thermal Protection
- Integrated 180mΩ Power Switches
- Mute / Standby Mode (Sleep)

Applications

- Televisions
- Home Stereo Systems
- Monitors

Figure 2: EV0066 Stereo Single Ended Schematic

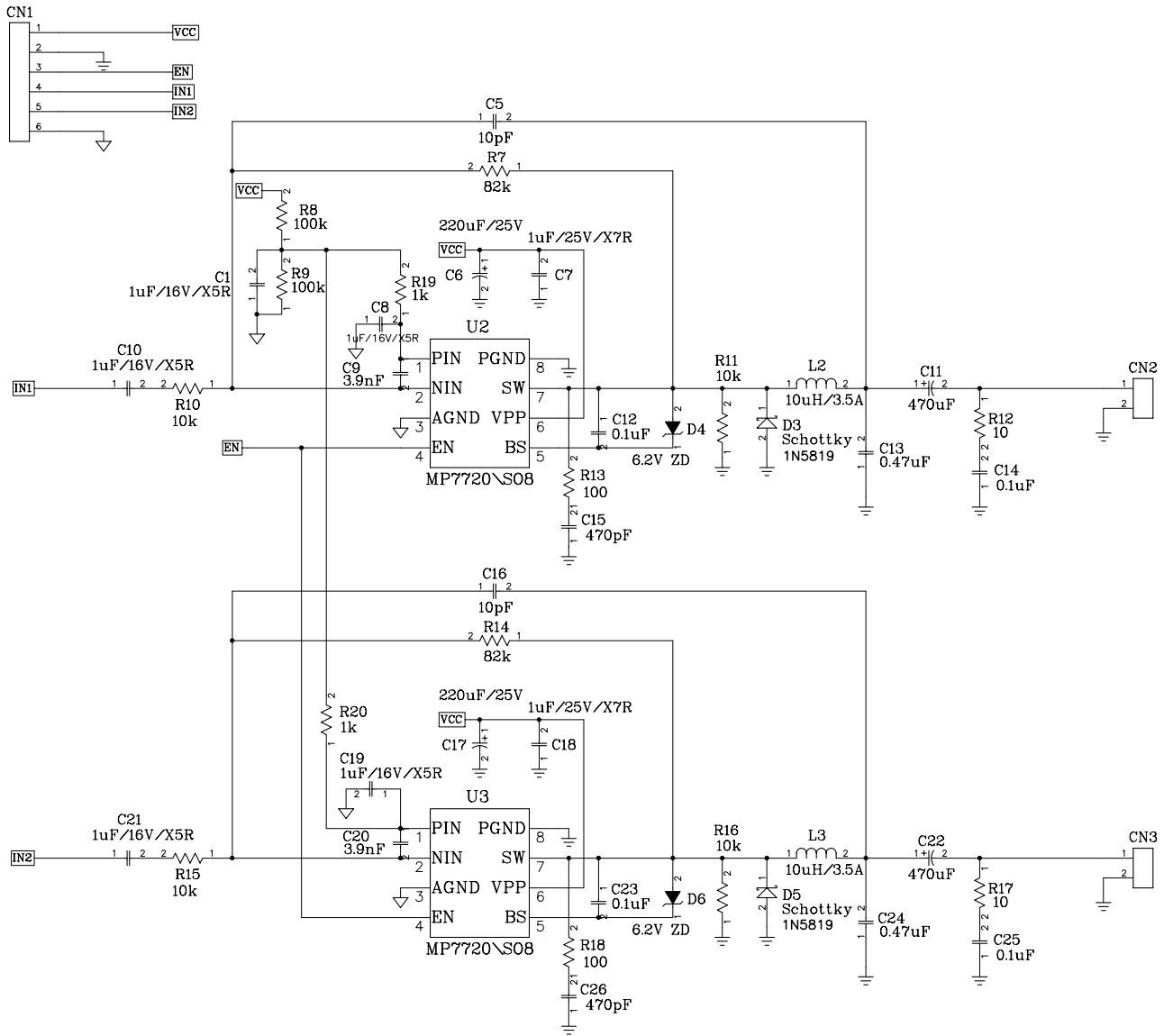

EV0066 / MP7720 Compact Stereo Evaluation Board Schematic
ev0066_mp7720_mini_rev_A.sch 8/19/03

Table 1: EV0066 Bill of Materials

Component	Description	Package	Qty
U2, U3	MP7720DS	SOIC8	2
D3, D5	1N5819 Shottky	SOD123	2
D4, D6	ZD Diode	SOD323	2
C1, C8, C10, C19, C21	1 μ F/16V/X5R	0603	5
C12, C23	0.1 μ F	0604	2
C15, C26	470pF	0605	2
C5, C16	10pF	0606	2
C9, C20	3.9nF	0607	2
C14, C25	0.1 μ F	1206	2
C7, C18	1 μ F/25V/X7R	1207	2
C13, C24	0.47 μ F Metal	1210	2
C11, C22	470 μ F	OD10P5.0	2
C6, C17	220 μ F/25V	OD8.0P3.5	2
CN2, CN3	2 Pin Connector	2MM	2
CN1	6 Pin Connector	2MM	1
L2, L3	10 μ H/3.5A Toko	D300\P200	2
R10, R11, R15, R16	10K Ω	0603	4
R13, R18	100	0604	2
R19, R20	1K Ω	0605	2
R7, R14	82K Ω	0606	2
R8, R9	100K Ω	0607	2
R12, R17	10	1206	2
		Total	48

Figure 3: THD+N vs. Output Power with $R_L = 4\Omega$, $V_{CC}=14V$, 1KHz

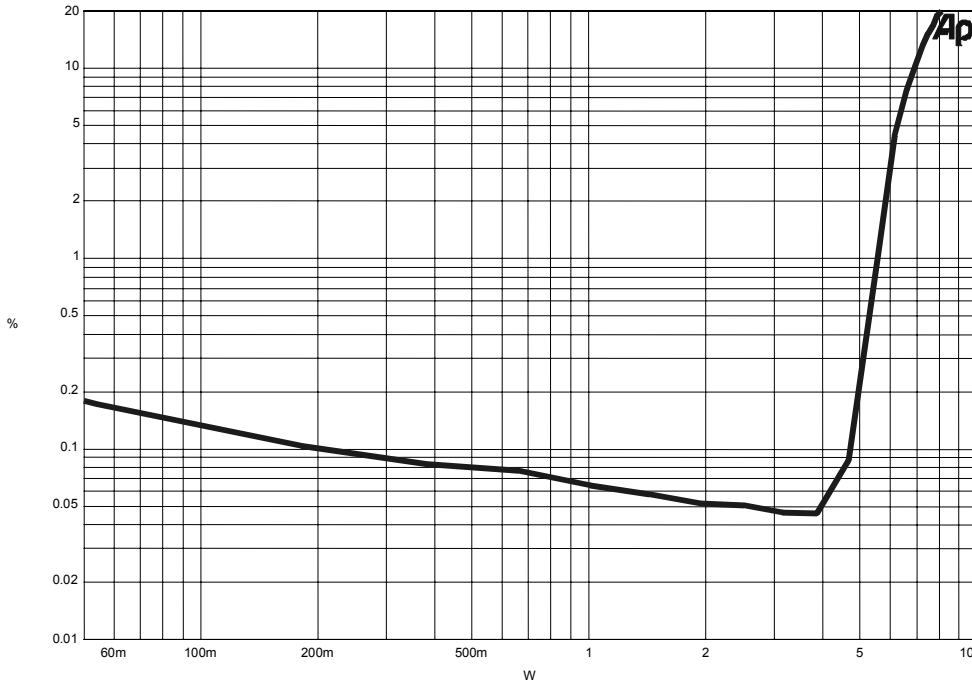

Figure 4: THD+N vs. Output Power with $R_L = 8\Omega$, $V_{CC}=14V$, 1KHz

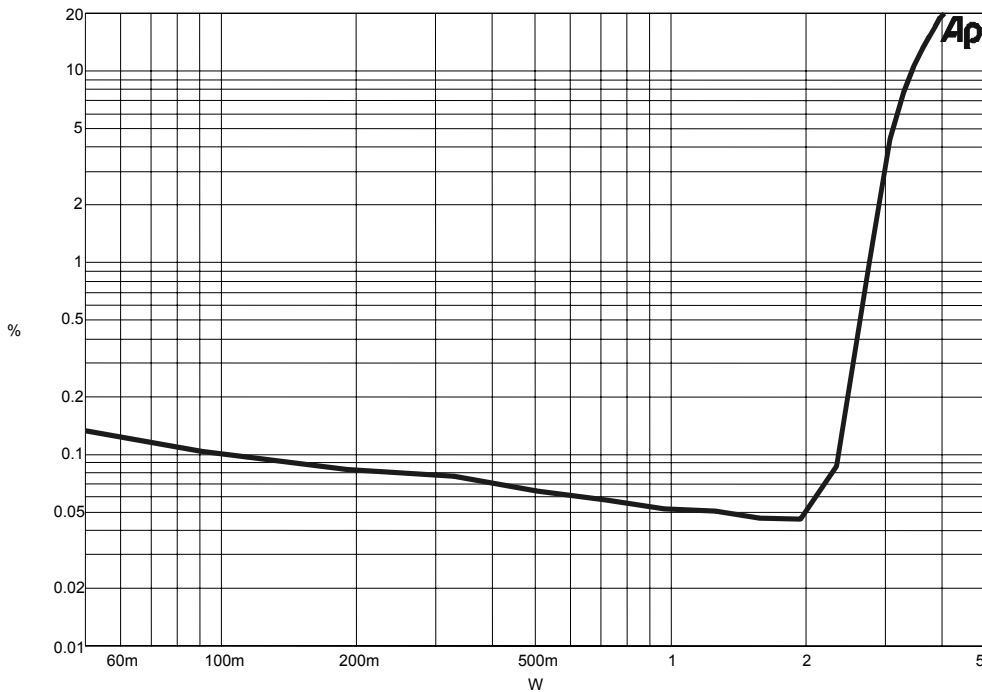
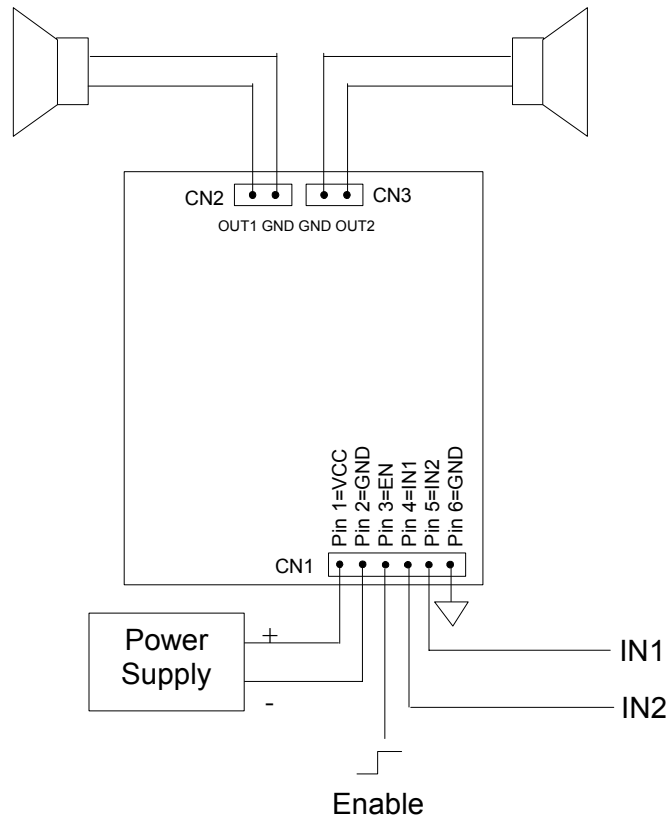

Figure 5: EV0066 Connection Diagram



Evaluation Board Operation

Power Requirements

1. Power supply: 7.5V to 24V, 6A maximum
2. 0V to 1V_{RMS} (max) audio signal source, $\leq 600\Omega$.
3. Speaker: 4 Ω or 8 Ω .

Setup Condition for 24V Operation

1. Connect + and - speakers terminals to OUT and GND pins of CN2 and CN3 respectively.
2. Connect the + and 1 power supply terminals to Pin 1 and 2 of CN1 respectively.
3. Adjust the power supply to $7.5 \leq V_{CC} \leq 24V$, (do not turn on).
4. Connect the audio input signal source to the amplifier inputs (IN1, IN2).
5. Turn on the power supply to apply power to the board.
6. To enable the board apply a voltage, $2V \leq V_{EN} \leq 6V$, to the EN pin. To disable the board connect the EN pin to ground.

Figure 6: Top Silk Layer

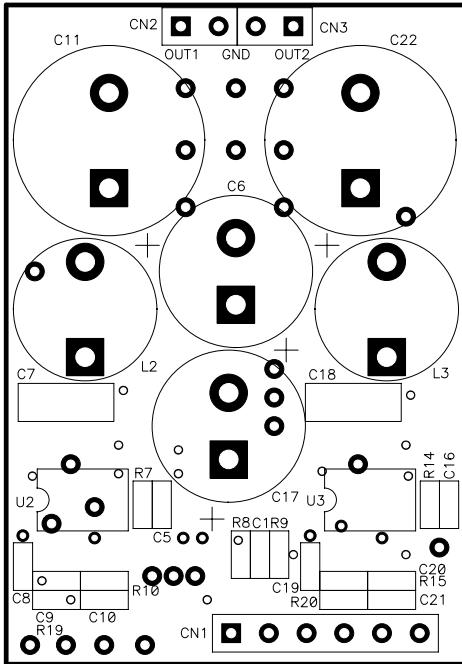

Figure 7: Top Layer

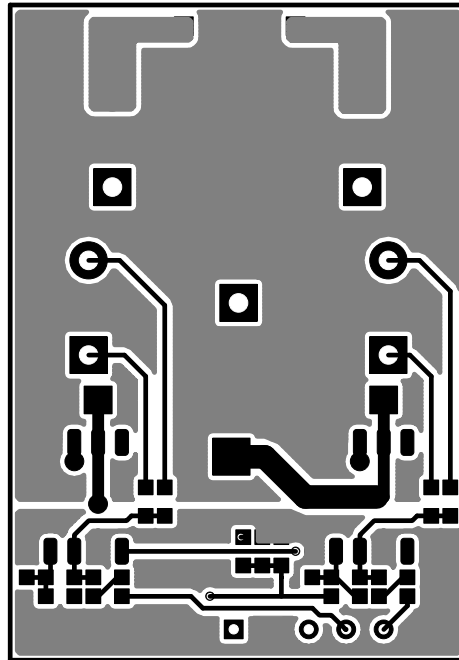

Figure 8: Bottom Layer

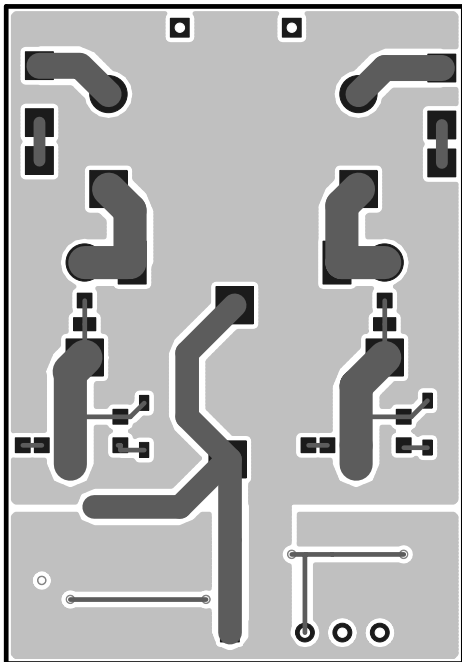
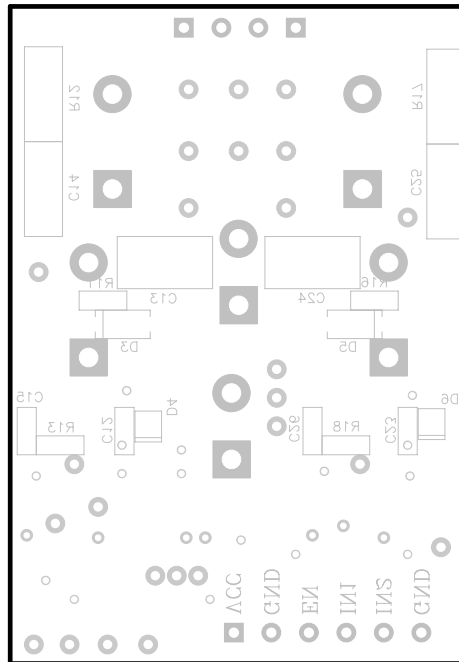

Figure 9: Bottom Silkscreen Layer



NOTICE: MPS believes the information in this document to be accurate and reliable. However, it is subject to change without notice. Please contact the factory for current specifications. No responsibility is assumed by MPS for its use or fit to any application, nor for infringement of patent or other rights of third parties.